

Scanner Parts

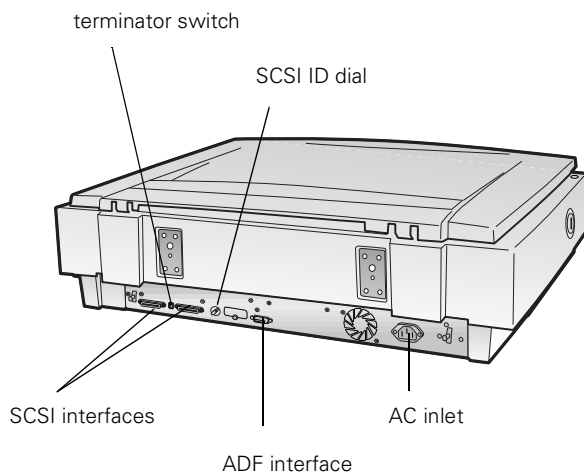
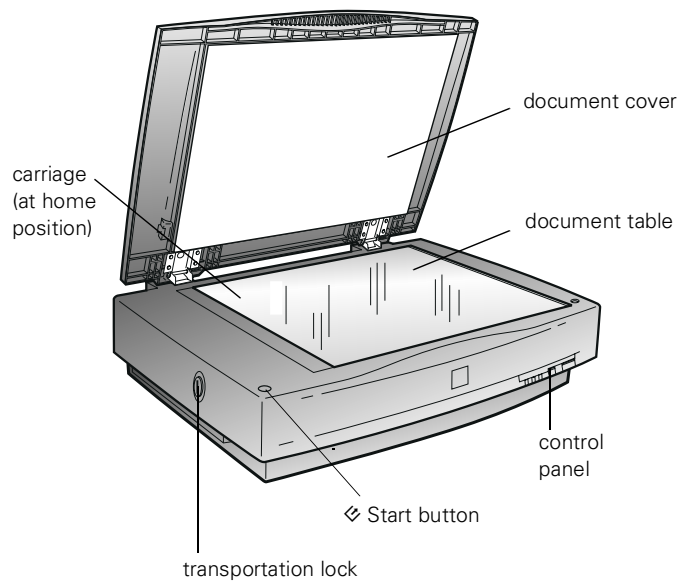

Scanner Specifications

Scanner type:	Flatbed, color
Photoelectric device:	Color CCD line sensor
Effective pixels:	7020 dots × 10200 pixels at 600 dpi, 100%
Document size:	11.7 × 17.0 inches (297 × 432 mm) (the reading area can be specified from your software)

Scanning resolution:	600 dpi main 2400 dpi sub with micro-step
Output resolution:	50 to 4800 dpi (1-dpi increments)
Command level:	ESC/I-B7
Color separation:	RGB color filters on CCD
Reading sequence:	Monochrome: 1-pass scanning Color byte sequence: 1-pass scanning (R, G, B) Color line sequence: 1-pass scanning (R, G, B)
Zoom:	50 to 200 percent in 1-percent increments
Image data:	36 bits input; 24 bits output (color) 12 bits input; 8 bits output (grayscale)
Brightness:	7 levels
Line art settings:	Fixed threshold with Text Enhancement Technology (TET) enabled
Halftoning process:	AAS (Auto Area Segmentation) Enable/disable selectable 3 halftoning modes (A, B, and C) 4 dither patterns (A, B, C, and D) for bi-level and quad-level data (2 downloadable dither patterns) 2 user-defined dither patterns (A, B)
Gamma correction:	2 types for CRT display 3 types for printer 1 user-defined table
Color correction:	1 type for CRT display 3 types for printer output (available in color byte sequence mode and color line sequence mode) 1 type user-defined
Interface:	SCSI II (two 50-pin high-density connectors)
Options:	Automatic Document Feeder (ADF)
Supported documents:	Opaque documents with smooth surfaces
Light source:	Xenon fluorescent lamp
Reliability:	Main unit MCBF: 100,000 cycles of carriage movements

Noise: Under 50 db (operating)
 Dimensions: Width: 25.8 inches (656 mm)
 Depth: 18.0 inches (458 mm)
 Height: 6.9 inches (176 mm)
 Weight: Approximately 46.3 lb (21 kg)

Electrical

Input voltage range: 100 to 120 VAC
 220 to 240 VAC; universal auto-switching
 Rated frequency: 50 to 60 Hz
 Rated current: 100 to 120 VAC—1.2 A
 220 to 240 VAC—0.7 A
 Power consumption: *Operating*
 Approximately 50 W (approximately
 55 W with the ADF)



Check the label on the back of the scanner for voltage information.

Environmental

Temperature: *Operating*
 41 to 95 °F (5 to 35 °C)
Standby
 -13 to 140 °F (-25 to 60 °C)
 Humidity (without condensation): *Operating*
 10 to 80%
Standby
 10 to 85%
 Operating conditions: Ordinary office or home conditions; avoid dust, direct sunlight, or strong light. Be sure the outlet provides enough power.

Safety Approvals

120 V

Safety standards: UL 1950 with D3
 CSA C22.2 No. 950 with D3
 EMC FCC part 15 subpart B class B (USA)
 CSA C108.8 class B (Canada)

230 V

Safety standards: EN 60950 (VDE)
 EMC EN 55022 (CISPR Pub 22) class B
 AS/NZS 3548 class B

CE marking

Low Voltage Directive
 73/23/EEC: EN60950
 EMC Directive
 89/336/EEC: EN 55022 Class B
 EN 61000-3-2
 EN 61000-3-3
 EN 50082-1
 IEC 801-2
 IEC 801-3
 IEC 801-4

SCSI Interface

Interface type: ANSI X3T9.2/375R Revision 10L (SCSI II)
 Functions: BUS FREE phase
 ARBITRATION phase
 SELECTION/RESELECTION phase
 COMMAND phase
 (the Logical Unit Number is fixed at 0 and the Command Link Function is not supported)
 DATA phase
 DATA IN phase
 DATA OUT phase
 STATUS phase
 MESSAGE phase
 MESSAGE IN phase
 MESSAGE OUT phase
 ATTENTION condition
 RESET condition
 Logic level: TTL compatible
 Electrical standard: ANSI X3T9.2/375R Revision 10L (SCSI II)
 ID Setting: Selectable from 0 to 7 (factory setting: 2)
 Terminator: Internal terminator selectable (enable/disable)

Connector type: Two Micro DB-50 high-density connectors

Connector pin arrangement:

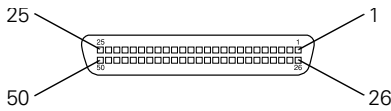

Initialization methods

Scanner is turned on or receives a SCSI Reset signal from the SCSI interface (hardware initialization).

Scanner receives a SCSI Bus Device message or an Esc @ command from the software (software initialization)

Optional Automatic Document Feeder (GT10000ADF)

The ADF allows you to automatically load multi-page documents into your scanner.

General

- Type: Page feeding and duplex scanning with automatic reverse
- Document feeding: Pages are center aligned, fed face up from bottom of stack, and ejected face up
- Document replacement time: 1.2 seconds (Letter/A4 landscape)
- Multiple sizes: Unavailable; all documents in a stack must be the same size
- Noise: 50 dB or less
- Reliability: 100,000 sheet paper feeding life
100,000 sheet paper ejecting life
100,000 hinge closings
- Dimensions: Width: 23.6 inches (601 mm)
Depth: 20.8 inches (528 mm)
Height: 4.8 inches (122 mm)
- Weight: 35.2 lb (16 kg)

Documents Supported

- Document size: Portrait: A3, Ledger, B4, Legal, A4, Letter, B5, A5, 5.5 × 5.8 inch (140 × 148 mm)
Landscape: A4, Letter, B5, A5
- Feeding capacity: 50 sheets of 21 lb (80 g/m²) paper: A4, Letter or smaller
30 sheets of 21 lb (80 g/m²) paper: B4, Legal or larger
- Ejecting capacity: 100 sheets
- Paper quality: High-quality bond paper
- Compatible paper types: High-quality paper, ink jet paper, bond paper
- Paper thickness: 13 to 33 lb (50 to 127 g/m²)



Don't use the following paper types: transparencies, tracing paper, coated paper (such as photo quality and glossy paper), labels, multipart forms, carbon paper, or paper with staples, holes, rips, curls, or folds.

Electrical

- Power supply: Supplied through the scanner
24 ± 10% VDC
5 ± 10% VDC
- Consumption current: 24 VDC: 2.0 A
5 VDC: 0.3 A
- Insulation resistance: 10 mΩ or more at 500 VDC (between AC line and chassis)
- Dielectric strength: 1000 VAC per minute (between AC line and chassis)
- Resistance to static electric noise: Case: Operated properly at 10 kV or less
Metal: Operated properly at 7 kV or less

Lights and Buttons



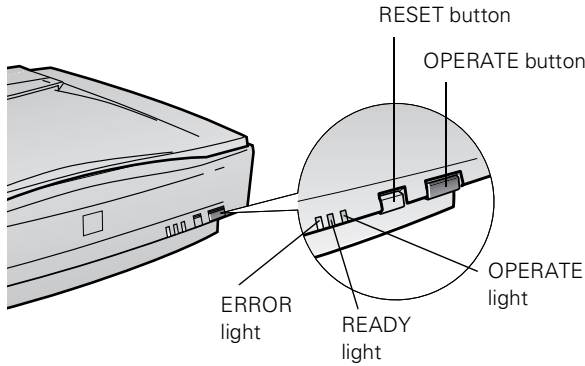

The scanner has three indicator lights and two buttons on its control panel. A  Start button is located beside the document table. Light status and button functions are described in the tables that follow.



Scanner indicator lights

Light	Light status	Color	Scanner status
READY	On	Green	Ready to scan images
	Flashing		Scanning in progress
ERROR	On	Red	An error has occurred
	Flashing		

Scanner buttons

Button	Function
 OPERATE	Turns the scanner on and off.
RESET	Initializes the scanner.
 Start	<p>Automatically launches a  Start button-compatible application. You must set up your scanner software and a compatible application to use this feature with any application other than Presto! PageManager.</p> <p>If you installed Presto! PageManager, it's automatically assigned to the  Start button. You can set up Presto! PageManager to scan your image automatically and send it directly to another application or a peripheral device, such as a printer.</p>

Error conditions

ERROR light	READY light	Error type
On	On	Command error: The scanner has received incorrect commands from the scanning software. Try rescanning.

Error conditions

Flashing	Off	Interface error: Make sure the scanner is securely connected to the computer, and then turn the scanner off and back on again.
Flashing	Flashing	Fatal error: Make sure the transportation lock is released, and then turn the scanner off and back on again.
Off	Off	Option error: There's a problem with the ADF unit. Make sure the ADF is flat against the document table. Make sure it is securely connected to the ADF connector at the back of the scanner. Finally, make sure the ADF isn't out of paper and doesn't have a paper jam.

Transporting the Scanner

When you transport the scanner a long distance or store it for an extended time, follow these steps to secure the carriage:

1. Make sure the transportation lock on the side of the scanner is in the UNLOCK position.
2. If you're using an automatic document feeder, remove it and replace the scanner cover.
3. Turn on the scanner and wait until the carriage moves to the home position (toward the left of the scanner). Then turn off the scanner.



If the scanner is inoperable, the carriage may not automatically return to the home position. If it doesn't, raise the right side of the scanner and hold it up until the carriage comes to rest at the left side. Then turn the transportation lock to the locked position.

4. Slide the transportation lock to the LOCK position.

Scanning with EPSON TWAIN Pro

Here is a brief overview of the scanning steps using EPSON TWAIN Pro (or EPSON TWAIN Pro Network).

1. Open your host application (for example, PhotoDeluxe Business Edition).
2. Select your scanner source. (Unless you change your source, you need to do this step only once.)

For example, if you're using PhotoDeluxe Business Edition as your host application, click the **Get & Fix Photo** button. Click the **Get Photo** tab, then click the arrow below the **Scanners** button. Select **EPSON TWAIN Pro** and click **OK**.

If you're accessing a network scanner connected to another computer, select **EPSON TWAIN Pro Network** as your input source and click **OK**.



You can't select EPSON TWAIN Pro as your scanner source if you're using a network scanner and EPSON Scan Server is running. EPSON Scan Server disables EPSON TWAIN Pro

3. Open your scanner driver. In PhotoDeluxe, do one of the following:
 - ❑ Click the **Get & Fix Photo** button. Click the **Get Photo** tab, then click the **Scanners** button. Click the **1 Mode** tab, then click the **Custom** button.
 - ❑ Choose **File, Open Special**, then select **Scan Photo**.



The command you choose from the File menu depends on the host application. With some applications, you might choose **Acquire** or **Select Source** instead of **Open Special**.

4. The EPSON TWAIN Pro main window appears.



click to display a preview of the image

click to start scanning

5. Choose the Document Source, Image Type, and Destination.

For example, if you're scanning a photograph to print, select **Flatbed** as your Document Source, **24-bit Color [Std]** as your Image Type, and **EPSON Stylus Printer [Photo]** as the Destination, if you're sending the scanned image to an EPSON Inkjet printer.

If you're using the optional automatic document feeder, select either **ADF - Single-sided** or **ADF - Double-sided** as your Document Source.

6. Click the **Preview** button. You see a preview of your scan in the window that opens.



7. Choose your scan settings.

Click the **Auto Locate** button to automatically define the scan area around the edges of your image. You can also adjust the scan area by positioning the mouse pointer over the dotted line around the marquee's edge and dragging the box to resize the marquee.

Click the **Color Adjustment** button and use the **Gray Balance Intensity** feature if you need to remove color cast from your image.

Click the **Auto Exposure** button to automatically set the highlight and shadow exposure.



Generally it's a good idea to use the **Auto Exposure** button to obtain the best settings for your scan.

8. When you've finished making adjustments, click the **Scan** button.

The **READY** light on the front of the scanner flickers while it's scanning. In a few moments, a scanned image is imported into your host application's window. Then click **Close** to close the EPSON TWAIN Pro or EPSON TWAIN Pro Network window and return to your application.

Scanning Color Images

If the colors in your scanned image don't match those in your original document, try experimenting with the **Unsharp Mask** setting. Click the **Destination** button on the EPSON TWAIN Pro or EPSON TWAIN Pro Network main window to display the Destination window, and then select or deselect **Unsharp Mask**.

Selecting Resolution

As a rule of thumb for most images except line art, use a scanning resolution that is approximately one third of your output resolution. For example, use a scanning resolution of up to 100 dpi with a 300 dpi laser printer, and up to 200 dpi with a 600 dpi laser printer. For 1440 dpi ink jet printers, use a scanning resolution of up to 300 dpi. Try a scanning resolution of 240 dpi for 720 dpi printing.

Keep the following in mind when you choose a resolution:

- ❑ The higher the resolution you select, the larger the resulting image file will be. To keep your file size manageable, select the lowest possible resolution that gives acceptable quality.
- ❑ If you need to scan at a higher resolution, you can reduce the size of the resulting image file by scanning only part of the image.

Using a Network Scanner

Network scanning involves the following steps:

- ❑ The scanner must be connected to the scanner server.
- ❑ The scanner and scanner server must be turned on and running EPSON Scan Server.
- ❑ From the client computer, start the host application, then start EPSON TWAIN Pro Network to establish a connection to the scanner server. Only one client computer at a time can connect to the scanner server.
- ❑ Choose the Image Type, Resolution, and other settings you want for your scan.
- ❑ Place your first image on the document table (or in the automatic document feeder).
- ❑ Start the scan. Although this can be done from EPSON TWAIN Pro Network on the client computer, it may be more convenient to press the scanner's Start button or to start the scan from the scanner server. Then you can scan several images with a single trip to the scanner.
- ❑ If you want to scan more than one image, place your second image on the document table and press the scanner's Start button again. Repeat this step for every image you want to scan. (The settings you chose for the first image apply to these images too.)

- ❑ When you return to the client computer, your scanned images appear in the host application's window. Close EPSON TWAIN Pro Network to end your connection to the scanner server and allow other client computers to use the scanner.



Some applications automatically close the client computer's connection to the scanner server when you press the Start button. You can't scan multiple images if you're using these applications.

Starting a Network Scan

You can start a scan on your network scanner in several ways:

- ❑ You can start EPSON TWAIN Pro Network on the client computer, make your scan settings, and click the **Scan** button on the EPSON TWAIN Pro Network main window.
- ❑ You can press the Start button on the scanner to send the scanned image to the client computer that is currently connected to the scanner server.
- ❑ You can click the **Start** button on the EPSON Scan Server dialog box to send the scanned image to the client computer currently connected to the scanner server.

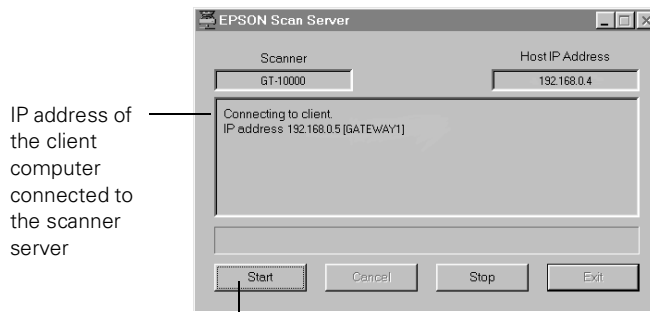

Stopping a Network Scan in Progress

You can stop a scan in progress from either the client computer or the scanner server.

- ❑ To cancel a scan from the client computer, click the **Cancel** button on the Progress bar.
- ❑ To cancel from the scanner server, click the **Cancel** button at the bottom of the EPSON Scan Server dialog box.
- ❑ To break the connection between the client computer and the scanner server, click the **Stop** button at the bottom of the EPSON Scan Server dialog box. This closes EPSON TWAIN Pro Network on the client computer and allows other client computers to connect to the scanner server.

Related Documentation

CPD-9639	EPSON GT-10000 User's Guide
	EPSON GT-10000 Software Reference Guide (html)
TM-GT10000	EPSON GT-10000 Service Manual
PL-GT10000	EPSON GT-10000 Parts Price List